

Advantage

Q-Series low-bed design with advanced clinical positioning

Q-Series
Quality. Detail. Value.

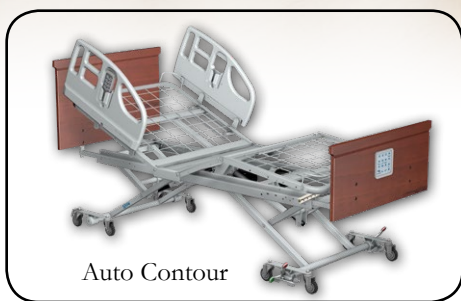

Auto Contour

The ADVANTAGE Bed
With smart technology enabling
advanced clinical and resident positioning.



Pendant
Controller



Foot-end
Controller



Comfort Chair



Reverse
Trendelenburg



Trendelenburg

www.spanamerica.com

SPAN
better science. better care.
a division of Savaria

Advantage Features

Q-Series
Quality. Detail. Value.

The **Advantage** model with Q-Series advanced features such as mobility at any height, easy optional sleep surface expansion to 42" and a multi-function dolly system.

Choice of 7 finishes and 8 head board profiles



Standard Melamine Profiles

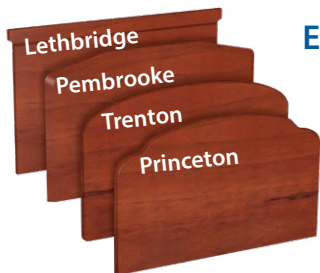

Elite HPL Profiles

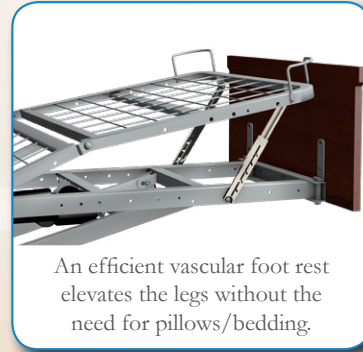

An efficient vascular foot rest elevates the legs without the need for pillows/bedding.



Optional 3-Position side assist rail offers dependable ingress-egress support.



Full mobility at any height; staff maneuvers from standing position for safer, quicker relocation.



In addition to the standard pendant controller, a foot-end control with staff-only lockout is available.

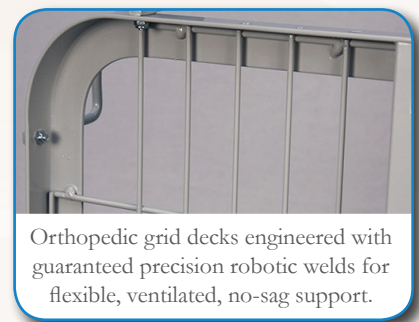

Orthopedic grid decks engineered with guaranteed precision robotic welds for flexible, ventilated, no-sag support.

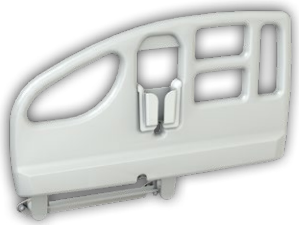

Optional, pleasant to touch molded plastic half-head assist rails. All rails also available in steel.

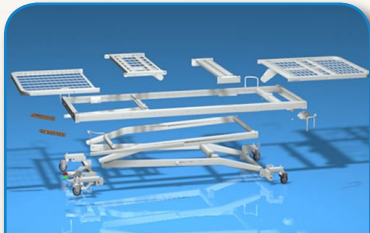

Bed components are individually powder-coated with a durable, flexible anti-microbial polyester finish.



Positively anchored retainers in four corners to eliminate mattress movement and dangerous gaps.



Optional dollies facilitate easy under-bed service and bed passage on its side through narrow doorways.



Decks have smooth upper surface for easy disinfection – preferable to decks with protruding welds.



Optional full 360° mobility and lockability at any height for safer, ergonomic bed relocation.

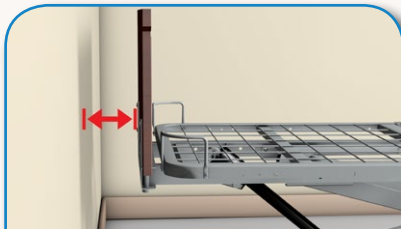

The bed adjusts vertically with virtually no horizontal motion, saving space and protecting the bed environment.

Now available: Tool-less expansion to 42"

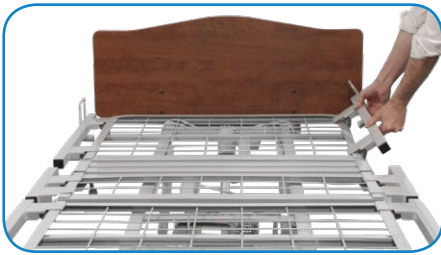

Attach easy-on expanders tool-lessly to both sides of the head, seat and foot decks after corner mattress retainers have been removed.



Spring-driven latches beneath the expander units attach firmly to the deck providing a 42" sleep surface for user comfort, fall prevention and ADLs.



Our molded plastic and metal half-head assist rails are both compatible with the expanders, mounting securely to the expanders before installation.

Q-Series

Quality. Detail. Value.

Q-Series standard features include:

- Precision welded orthopedic grid decks
- Durable, anti-microbial polyester powder-coating of metal components
- Smooth deck design for easier cleaning
- Mobility at any height
- Vascular foot rest with easy ratchet operation
- Beds move vertically with virtually no horizontal motion
- Arched legs allow wide stance for clearance and stability
- Honeycomb bumpers protect walls
- Pendant bed controller

Optional features:

- 42" Tool-less bed expanders
- Foot end controller with lockout
- Molded half-head assist rail
- Dollies for streamlined bed logistics and maintenance
- Stylish head and foot board options
- Bed extenders
- Mobility options including floor level locking

Height Floor to Mattress Support	7-7/8" – 30"
Deck Angles - Back Elevation	0 – 70°
Deck Angles - Knee Elevation	0 – 30°
Bed Length - Overall Length	84-3/4" / 88-3/4"
Bed Length - Sleep Surface	76" / 80"
Bed Width - Sleep Surface	35"
Weight of Bed (without accessories)	160 lbs / 73 kg
Safe Working Load	500 lbs / 227 kg
Warranty	Mechanical: 5 years Frame: 15 years Welds: 15 years

Build your own Q-Series bed online with our interactive configurator at www.configuredbed.com



Advantage

Item #	Description
QD1000*	Advantage bed 35" x 80"
QD1000MLF	Advantage bed 35" x 80"; 360° mobility; FEC; floor lock
QD1000Y	Advantage bed 35" x 76"
QD1000YMLF	Advantage bed 35" x 76"; 360° mobility; FEC; floor lock
*Other models	add suffixes: 'Y' for 76" deck / 'M' for 360° mobility / 'L' for floor lock / 'F' for foot end controls
Q6599	Head end roller bumpers
RM930	Three position pivot assist rail - universal
RM937	Three position molded pivot assist rail
RM950	Fixed assist rail - universal
RAD306H	Standard half head end side rail - set
RAD307H	Set of molded half head end side rails
RAD307H-L	Left side molded half head end side rail
RAD307H-R	Right side molded half head end side rail
RAD501	Three quarter length collapsible side rails
Q6416LP	Plastic pendant holder - head/foot board mount
Q6417LP	Gooseneck pendant holder - board mount
Q6730	Patient helper, trapeze bar, chain and hand grip
Q6733	Trapeze bracket
CS82	IV pole adjustable

Contact your local Span Representative
or call Beds/Furniture Customer Service:
800-268-8671

www.spanamerica.com

SPAN
better science. better care.
a division of Savaria